

INSTALLATION MANUAL

**PSW
1000**

POWERED SUBWOOFER

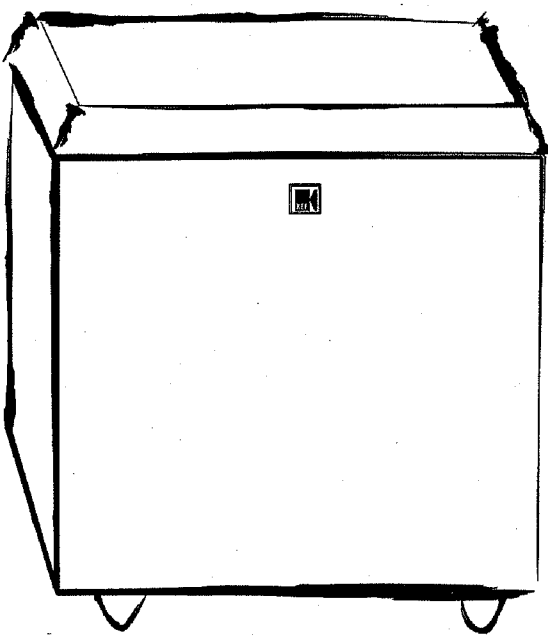

SAFETY INFORMATION

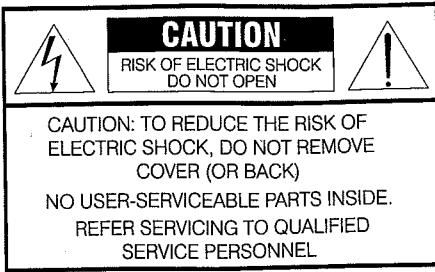

WARNING: TO REDUCE THE RISK OF FIRE OR ELECTRICAL SHOCK, DO NOT EXPOSE THIS APPLIANCE TO RAIN OR MOISTURE.

- A combined mains power input lead and country specific mains plug is provided.
- Check before connecting to your local mains supply that the local supply voltage is the same as that marked on the rear panel. If it is not, check with your supplier before proceeding. Under normal conditions, the appliance may be left 'ON'. However, it is good practice to switch off the mains supply if you are going on vacation or if the subwoofer is not going to be used for an extended period of time. For specific markets an appropriate power lead is supplied.
- The mains fuse is dependant on the local mains supply voltage and should be a 20mm cartridge-type anti-surge fuse. For 230V operation the fuse should be a T2.5AL Amp type. For 115V operation the fuse should be a T2.5AL Amp rating type.

Explanation of Graphical Symbols

 The lightning flash with arrowhead symbol, within an equilateral triangle, is intended to alert the user to the presence of uninsulated "dangerous voltage" within the products enclosure that may be of a sufficient magnitude to constitute a risk of electrical shock to persons.

 The exclamation point within an equilateral triangle is intended to alert the user to the presence of important operating and maintenance (servicing) instructions in the literature accompanying the appliance.

FOR UK:

WARNING: THIS APPLIANCE MUST BE EARTHED

The mains lead is terminated with a moulded three pin plug.

Should the plug on the flexible cord not be of the type for your socket outlets do not use an adaptor but remove the plug from the cord and discard. Carefully prepare the end of the supply cord and fit a suitable plug.

IMPORTANT

The wires in this mains lead are coloured in accordance with the following code:

Green and Yellow: Earth
Blue: Neutral
Brown: Live

As the colours of the wires in the mains lead of this appliance may not correspond with the coloured markings identifying the terminals in your plug, proceed as follows:

The wire which is coloured Green and Yellow must be connected to the terminal in the plug which is marked with the letter E or by the earth symbol \perp or coloured Green or Green and Yellow.

The wire which is coloured Blue must be connected to the terminal which is marked by the letter N or coloured Black.

The wire which is coloured Brown must be connected to the terminal which is marked the letter L or coloured Red.

FOR USA:

The power cord is terminated with a moulded two pin US plug.

FOR EUROPE:

A mains lead compatible with national earthing standards and complying with the local safety requirement is supplied.

IMPORTANT SAFETY INSTRUCTIONS

Please take heed of the following before using the KEF Model PSW1000. Note also that the word "appliance" shall refer to the KEF PSW1000 subwoofer, or any part of it.

1. **Read Instructions** - All the Safety and Operating Instructions should be read before the appliance is operated.
2. **Retain Instructions** - The Safety and Operating Instructions should be retained for future reference.
3. **Heed Warnings** - All warnings on the appliance and in the Operating Instructions should be adhered to.
4. **Follow Instructions** - All Operating and Use Instructions should be followed.
5. **Water and Moisture** - The appliance should not be used in or near water - for example, near a bathtub, washbowl, kitchen sink, laundry tub, in a wet basement, or near a swimming pool, and the like.
6. **Carts and Stands** - The appliance should be used only with a cart or stand that is recommended by the manufacturers. Furthermore, said cart or stand should be moved with care. Quick stops, excessive force and uneven surfaces may cause the appliance/cart combination to overturn.
7. **Wall or Ceiling Mounting** - The appliance should be mounted to a wall or ceiling as recommended by the manufacturer.
8. **Ventilation** - The appliance should be situated so that its location or position does not interfere with its proper ventilation. For example, the appliance should not be situated on a bed, sofa, rug or similar surface that may block any ventilation openings; or placed in a built-in installation, such as a bookcase or cabinet that may impede the flow of air through the ventilation openings.
9. **Heat** - The appliance should be situated away from heat sources such as radiators, heat registers, stoves or other appliances (including amplifiers) that produce heat.
10. **Power Sources** - The appliance should be connected to a power supply only of the type described in the operating instructions or as marked on the appliance.
11. **Grounding or Polarisation** - The precautions should be taken so that the grounding or polarisation means of an appliance are not defeated.
12. **Power-cord Protection** - Power supply cords should be routed so that they are not likely to be walked on or pinched by items placed upon or against them, paying particular attention to cords at plugs, convenience receptacles and the point where they exit from the appliance.
13. **Cleaning** - The appliance should be cleaned only as recommended by the manufacturer.
14. **Non-use Periods** - The power cord of the appliance should be unplugged from the outlet or turn off the "ON/OFF" switch when left unused for a long period of time.
15. **Object and Liquid Entry** - Care should be taken so that objects do not fall and liquids are not spilled into the enclosure through openings.
16. **Damage Requiring Service** - The appliance should be serviced by qualified service personnel when:
 - a) The power supply cord or the plug has been damaged; or
 - b) Objects have fallen or liquid has been spilled into the appliance; or
 - c) The appliance has been exposed to rain; or
 - d) The appliance does not appear to operate normally or exhibits a marked change in performance; or
 - e) The appliance has been dropped or the enclosure damaged.
17. **Servicing** - The user shall not attempt to service the appliance beyond that described in the Operating Instructions. All other servicing should be referred to qualified service personnel.



INTRODUCTION / Introduction(F)

- (GB) Thank you for purchasing the KEF Model PSW1000 powered AV subwoofer. We are confident that your PSW1000 will provide reliable, high performance sound for many years to come. Please read this manual fully before you attempt any connections to the model PSW1000.
- (F) KEF vous remercie de votre achat d'un subwoofer AV modèle PSW1000. Nous sommes convaincus que votre haut-parleur PSW1000 vous procurera un son fiable et de hautes performances pendant de longues années. Veuillez lire intégralement le présent manuel avant de procéder à des connexions quelconques.

USING THE MANUAL / Utilisation du manuel(F)

- (GB) The following icons are used throughout this manual to help you safely install your new speakers. **Please follow them carefully.**
- (F) Les icônes reprises ci-après sont utilisées dans tout le manuel de manière à vous aider à installer vos nouveaux haut-parleurs en sécurité. **Veillez suivre scrupuleusement leur signification.**



(GB) Correct
(F) Correct



(GB) Wrong
(F) Incorrect



(GB) Option
(F) Option



(GB) Adjustment
(F) Réglage



(GB) Electrical Warning
(F) Danger électrique



(GB) Caution/Warning
(F) Attention/
Avertissement



(GB) Positive/RED
(F) Positif/ROUGE

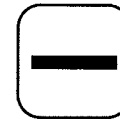

(GB) Negative/BLACK
(F) Négatif / NOIR



(GB) Switch off appliance
(F) Couper l'appareil



(GB) Inspect
(F) 'A inspecter'



(GB) Read
(F) 'A lire'



(GB) Sound changes
(F) Modifications du son

IMPORTANT POINTS / Points importants(F)



(GB) Do not use spirit based cleaners.
(F) Ne pas utiliser d'agents nettoyants à base d'alcool.

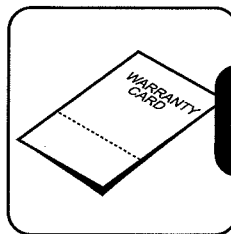

(GB) Read and return warranty card.
(F) Veuillez lire et renvoyer la carte de garantie.



(GB) Avoid damp.
(F) Eviter l'humidité.

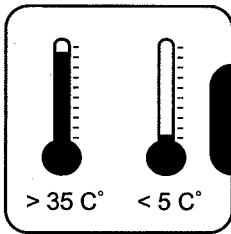

(GB) Avoid temperature extremes.
(F) Eviter les températures extrêmes.

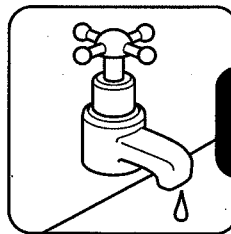

(GB) Clean with a damp lint free cloth.
(F) Nettoyer à l'aide d'un chiffon humide, non pelucheux.

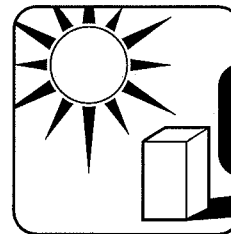

(GB) Avoid direct sunlight.
(F) Eviter l'exposition directe aux rayons du soleil.

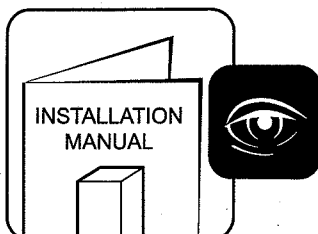

(GB) Follow this manual carefully for best results from speakers.
(F) Afin de tirer les meilleurs résultats des haut-parleurs, veuillez suivre scrupuleusement les instructions reprises dans le présent manuel.



(GB) SAFETY NOTICE! trailing cables are dangerous, secure all cables.
(F) NOTE DE SECURITE! Les câbles de haut-parleurs traînant sur le sol peuvent être source de danger. Fixer tous les câbles.

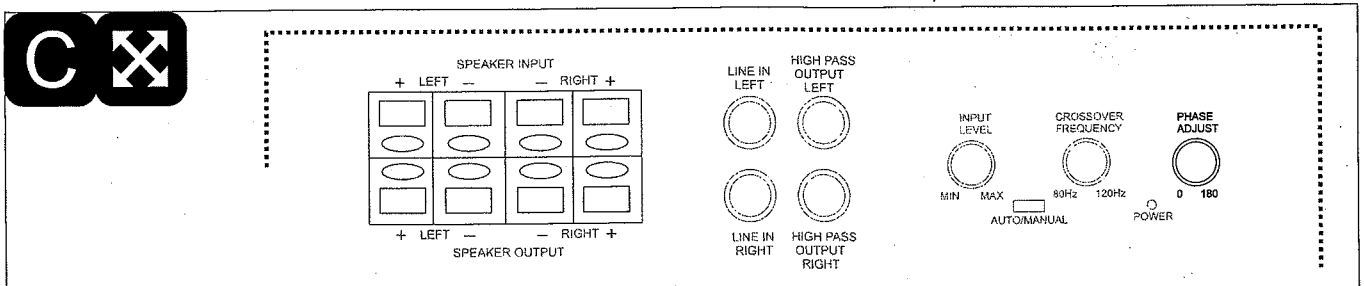
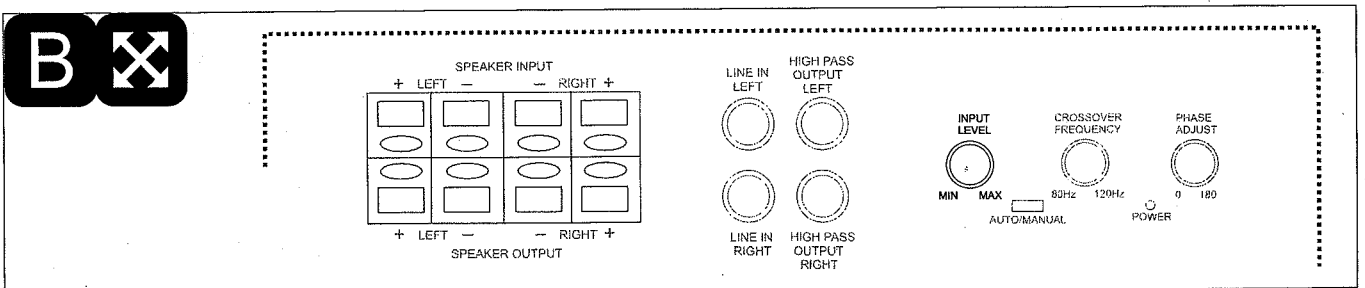
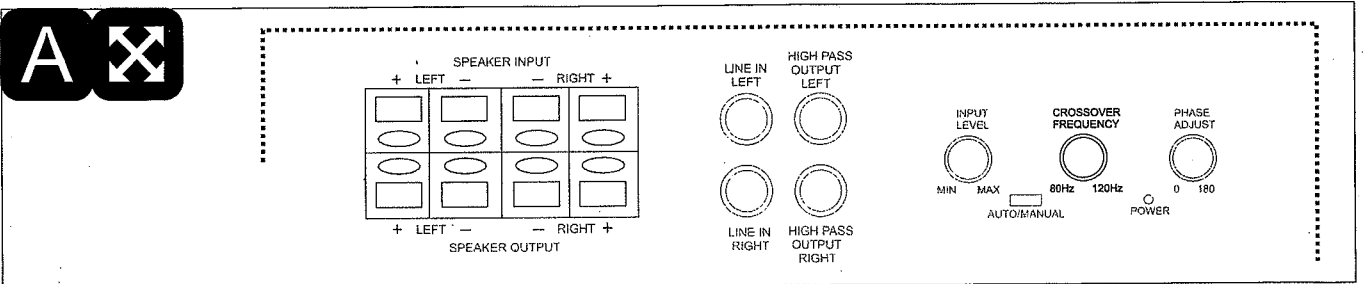
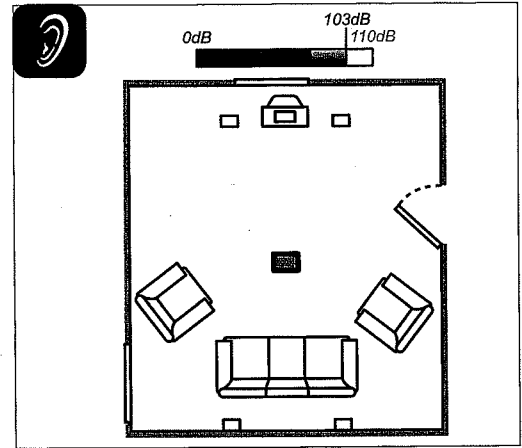
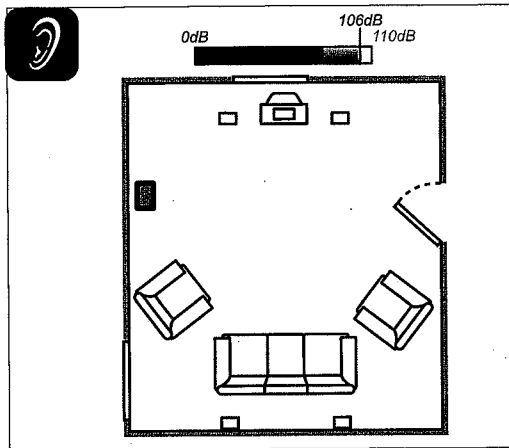
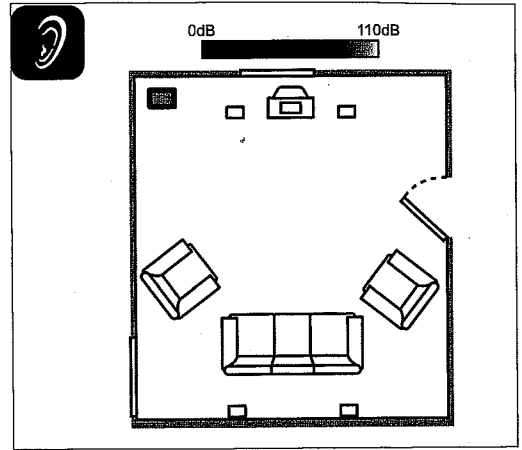
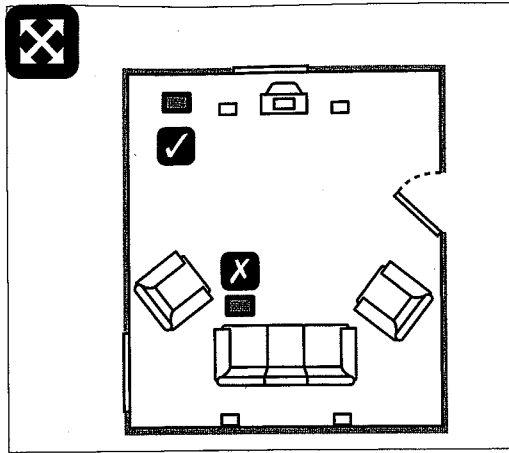

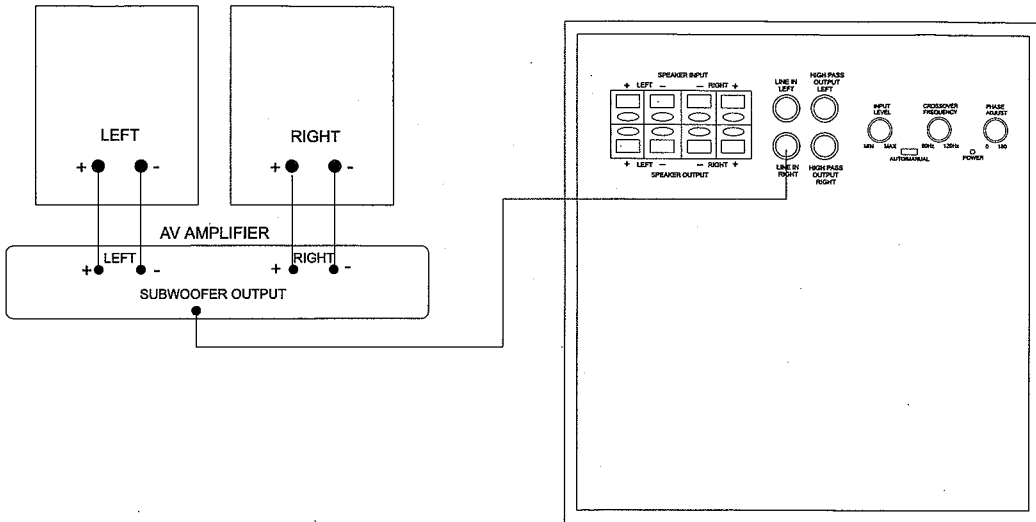
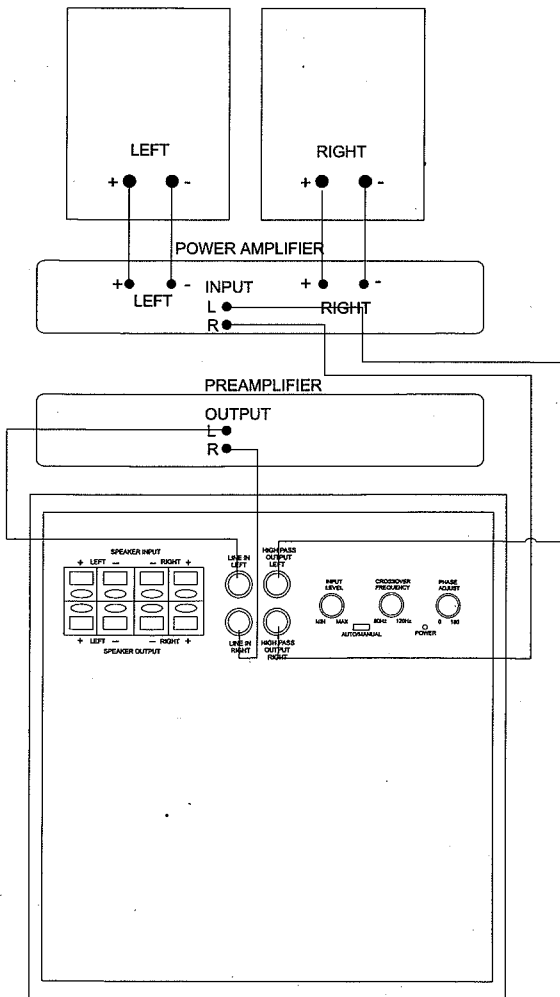
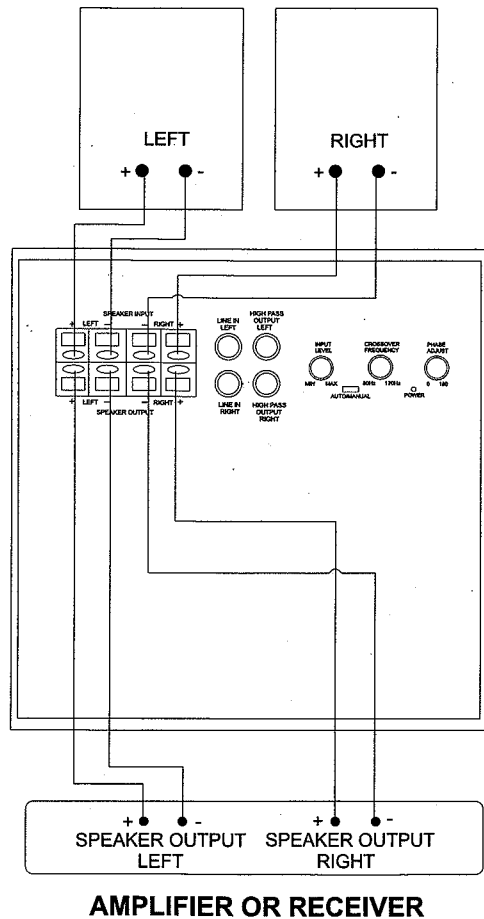
A **SATELLITE SPEAKERS****B** **SATELLITE SPEAKERS****C** **SATELLITE SPEAKERS**

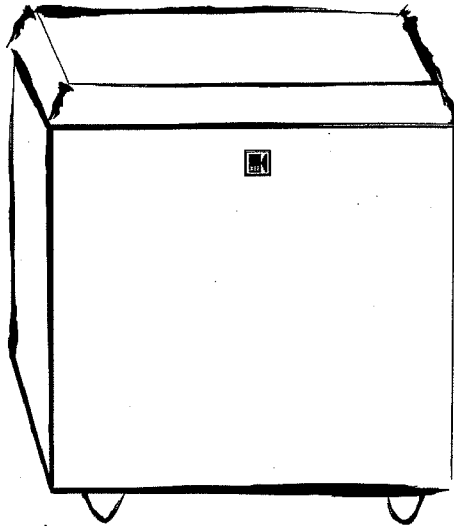

Model	PSW1000
Type	Powered subwoofer
LF Drive Unit	1 x 210mm (8") with coated pulp cone and magnetic shielding
Frequency Range	35 Hz to 150 Hz Upper frequency cut-off is variable between 80Hz and 120Hz +/- 3dB
Enclosure Type	Bass reflex
Internal Volume	15 litres
Amplifier Output Power	100 Watts
Low Level Signal Inputs	RCA phono sockets
High Level Signal Inputs	Spring clips
Low Level Signal Outputs	RCA phono sockets (Actively filtered at 14dB/octave @60-170Hz)
High Level Signal Outputs	Spring clips (Actively filtered at 6dB/octave @130Hz)
Net Weight	11.5kg
Dimensions (H x W x D)	mm 370 x 320 x 320
	In. 14.6 x 12.6 x 12.6
Power Requirements	115V ac ~, 60Hz 230V ac ~, 50Hz
Finish	Cherry or Black Ash effect

NOTE:

KEF AUDIO reserve the right, in line with continuous research and development, to amend or change specifications without prior notice. E. & O.E.