

# Q S E R I E S

Q1  
Q3  
Q5  
Q7  
Q8s  
Q9c

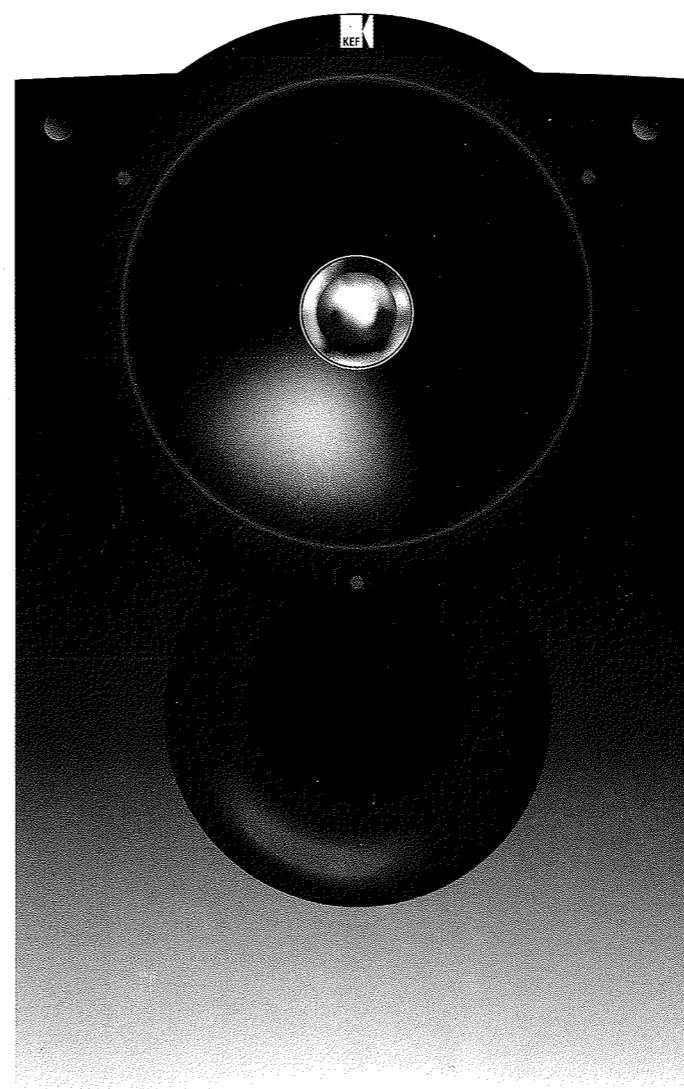

- |                                  |                                  |                                |
|----------------------------------|----------------------------------|--------------------------------|
| <b>GB</b> Installation Manual    | <b>F</b> Manuel d'installation   | <b>D</b> Installationshandbuch |
| <b>I</b> Manuale d'installazione | <b>ES</b> Manual de instalación  | <b>P</b> Manual de instalação  |
| <b>NL</b> Installatiehandleiding | <b>DK</b> Installationsanvisning |                                |



- (GB)** Thank you for purchasing these KEF loudspeakers. We are confident that they will provide reliable, high performance sound for many years to come. Please follow this manual carefully as it gives important information about positioning and connecting your KEF loudspeakers.
- (F)** Nous vous remercions pour l'achat de ces haut-parleurs KEF. Nous sommes persuadés qu'ils vous procureront pendant de nombreuses années un plaisir d'écoute de haute qualité. Veuillez à lire attentivement ce manuel. Il contient d'importantes informations sur la manière d'installer et de raccorder vos haut-parleurs KEF.
- (D)** Wir danken für Ihre Entscheidung zum Kauf von KEF Lautsprechern. Die Lautsprecher wurden sehr sorgfältig produziert und wir sind sicher, daß Sie Ihnen für viele Jahre Freude bereiten werden. Lesen Sie bitte diese Bedienungsanleitung aufmerksam durch. Sie erfahren darin wichtige Informationen für die Aufstellung und den Anschluß Ihrer Lautsprecher.
- (I)** Grazie per avere acquistato questi diffusori KEF. Noi siamo certi che essi forniranno per molti anni eccellenti prestazioni e un suono di alta qualità. Leggere attentamente il manuale, poiché esso fornisce importanti informazioni circa la loro disposizione e il loro collegamento.
- (ES)** Gracias por adquirir estos altavoces KEF. Con ellos podrá disfrutar durante mucho tiempo de una experiencia musical precisa y de gran calidad de sonido. Le rogamos lea atentamente este manual, que le proporcionará información importante para la ubicación y conexión de sus altavoces KEF.
- (P)** Obrigado pela aquisição destas colunas KEF. Estamos certos que lhe irão proporcionar um som de elevada performance por muitos anos. Leia cuidadosamente o manual de instruções, uma vez que lhe fornece uma série de informações importantes sobre o posicionamento e ligação das suas colunas KEF.
- (NL)** Wij stellen het zeer op prijs dat u deze KEF luidsprekers gekocht hebt. Wij vertrouwen er op dat ze u jaren veel muzikaal genoegen zullen verschaffen. Lees deze handleiding zorgvuldig, want hij geeft de juiste informatie over plaatsing en aansluiting van uw luidsprekers.
- (DK)** Tak for Deres valg af disse KEF højttalere. Vi er overbeviste om, at De vil have glæde af den fine lydgenivelse i mange år frem. Vær venlig at følge denne instruktionsbog nøje, da den giver vigtige oplysninger om placering og tilslutning af Deres KEF højttalere.

<b>1</b>	<b>(GB)</b> Important Points <b>(F)</b> Points important <b>(D)</b> Wichtige Punkte <b>(I)</b> Punti importanti <b>(ES)</b> Puntos importantes <b>(P)</b> Pontos importantes <b>(NL)</b> Belangrijke aandachtspunten <b>(DK)</b> Vigtige punkter
<b>2</b>	<b>(GB)</b> Positioning <b>(F)</b> Positionnement <b>(D)</b> Aufstellung <b>(I)</b> Posizionamento <b>(ES)</b> Posicionamiento <b>(P)</b> Posicionamiento <b>(NL)</b> Plaats en aansluiting <b>(DK)</b> Placering
<b>3</b>	<b>(GB)</b> Connections <b>(F)</b> Connexions <b>(D)</b> Anschlüsse <b>(I)</b> Collegamenti <b>(ES)</b> Conexiones <b>(P)</b> Ligações <b>(NL)</b> Aansluitingen <b>(DK)</b> Forbindelser
<b>4</b>	<b>(GB)</b> Fault Finding <b>(F)</b> Depannage <b>(D)</b> Fehlersuche <b>(I)</b> Individuazione delle anomalie <b>(ES)</b> Localización de averías <b>(P)</b> Detector de falhas <b>(NL)</b> Opsporen van storingen <b>(DK)</b> Fejlfinding
<b>5</b>	<b>(GB)</b> Specifications <b>(F)</b> Spécifications <b>(D)</b> Technische Merkmale <b>(I)</b> Specifiche <b>(ES)</b> Especificaciones <b>(P)</b> Especificações <b>(NL)</b> Technische gegevens <b>(DK)</b> Specifikationer

**(GB)** The following icons are used throughout this manual to help you safely install your new speakers.  
**Please follow them carefully.**

**(F)** Les icônes reprises ci-après sont utilisées dans tout le manuel de manière à vous aider à installer vos nouveaux haut-parleurs en toute sécurité.  
**Veillez suivre scrupuleusement leur signification.**

**(D)** Die folgenden Symbole finden Sie in der gesamten Anleitung. Sie erleichtern eine sichere Installation Ihrer neuen Lautsprecher.  
**Bitte achten Sie sorgfältig auf die Symbole.**

**(I)** Le seguenti icone usate nel manuale aiutano ad installare correttamente i diffusori.  
**Si raccomanda di seguirle con attenzione.**

**(ES)** Se utilizan los iconos siguientes en este manual para ayudarle a instalar con seguridad sus nuevos altavoces.  
**Signalas cuidadosamente.**

**(P)** Os seguintes ícones são utilizados no manual afim de o ajudarem a instalar com segurança as suas novas colunas.  
**Siga-os cuidadosamente.**

**(NL)** De hierna volgende pictogrammen worden in de hele handleiding gebruikt om u te helpen bij het veilig aansluiten en gebruiken van uw nieuwe luidsprekers.  
**Volg de instructies steeds nauwgezet op.**

**(DK)** Følgende symboler benyttes i denne manual, for at hjælpe dig med sikker installation af dine højttalere.  
**Følg dem nøje.**



**(GB)** Correct  
**(F)** Correct  
**(D)** Richtig  
**(I)** Corretto  
**(ES)** Correcto  
**(P)** Correcto  
**(NL)** Juist  
**(DK)** Korrekt



**(GB)** Wrong  
**(F)** Incorrect  
**(D)** Falsch  
**(I)** Errato  
**(ES)** Incorrecto  
**(P)** Errado  
**(NL)** Fout  
**(DK)** Forkert



**(GB)** Adjustment  
**(F)** Réglage  
**(D)** Einstellung  
**(I)** Regolazione  
**(ES)** Ajuste  
**(P)** Ajuste  
**(NL)** Instelling  
**(DK)** Justering



**(GB)** Caution/Warning  
**(F)** Attention/ Avertissement  
**(D)** Achtung / Warnung  
**(I)** Attenzione/Avvertenza  
**(ES)** Precaución/Atención  
**(P)** Atenção/ Aviso  
**(NL)** Opgelet/Waarschuwing  
**(DK)** Forsigtigt / Advarsel



**(GB)** Positive/RED  
**(F)** Positif / ROUGE  
**(D)** Positiv / ROT  
**(I)** Positivo / ROSSO  
**(ES)** Positivo / ROJO  
**(P)** Positivo/Vermelho  
**(NL)** Positief / ROOD  
**(DK)** Positiv / RØD

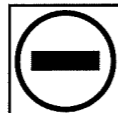

**(GB)** Negative/BLACK  
**(F)** Négatif/NOIR  
**(D)** Negativ/SCHWARZ  
**(I)** Negativo/NERO  
**(ES)** Negativo/NEGRO  
**(P)** Negativo/Preto  
**(NL)** Negatief/ZWART  
**(DK)** Negativ/SORT

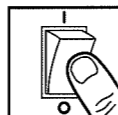

**(GB)** Switch off appliance  
**(F)** Couper l'appareil  
**(D)** Gerät abschalten  
**(I)** Disattivazione dell'apparecchio  
**(ES)** Interruptor del aparato  
**(P)** Interruptor para desligar  
**(NL)** Het toestel uitschakelen  
**(DK)** Afbryd apparatet



**(GB)** Read  
**(F)** 'A lire'  
**(D)** Lesen  
**(I)** Leggere  
**(ES)** Lea  
**(P)** Leia  
**(NL)** Lees  
**(DK)** Gennemlæs

**(GB)** Important Points  
**(F)** Points importants  
**(D)** Wichtige Punkte  
**(I)** Punti importanti

**(ES)** Puntos importantes  
**(P)** Pontos importantes  
**(NL)** Belangrijke aandachtspunten  
**(DK)** Vigtige punkter

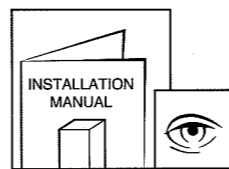

**(GB)** Follow this manual carefully for best results from speakers.  
**(F)** Afin de tirer les meilleurs résultats des haut-parleurs, veuillez suivre scrupuleusement les instructions reprises dans le présent manuel.  
**(D)** Für optimale Ergebnisse mit Ihrem Lautsprecher befolgen Sie diese Anleitung.  
**(I)** Per ottenere le migliori prestazioni dai diffusori seguire le istruzioni contenute nel presente manuale.  
**(ES)** Siga las instrucciones de este manual para obtener los mejores resultados de los altavoces.  
**(P)** Siga este manual atentamente para obter o melhor resultado das colunas.  
**(NL)** Volg terwille van een optimaal resultaat de instructies nauwkeurig op.  
**(DK)** Følg denne manual omhyggeligt for at opnå det bedste resultat fra højttalerne.

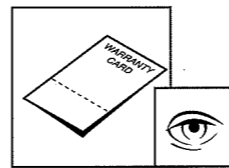

**(GB)** Read and return warranty card.  
**(F)** Veuillez lire et renvoyer la carte de garantie.  
**(D)** Lesen Sie die Garantiekarte und senden Sie sie ausgefüllt zurück.  
**(I)** Si prega di restituire la scheda di garanzia, previa attenta lettura.  
**(ES)** Lea y envíenos la tarjeta de garantía.  
**(P)** Leia e devolva o cartão de garantia.  
**(NL)** U kunt na lezing en invulling de garantietaal aan de importeur sturen.  
**(DK)** Gennemlæs og send garantibeviset tilbage.

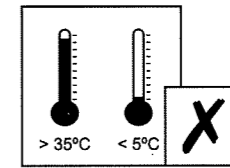

**(GB)** Avoid temperature extremes.  
**(F)** Eviter les températures extrêmes.  
**(D)** Extreme Temperaturen vermeiden.  
**(I)** Evitare temperature troppo alte o troppo basse.  
**(ES)** Evite temperaturas extremas.  
**(P)** Evite temperaturas extremas.  
**(NL)** Vermijd extreme temperaturen.  
**(DK)** Undgå ekstreme temperaturer.

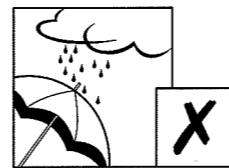

**(GB)** Avoid damp.  
**(F)** Eviter l'humidité.  
**(D)** Feuchtigkeit vermeiden.  
**(I)** Evitare l'umidità.  
**(ES)** Evite la humedad.  
**(P)** Evite a humidade.  
**(NL)** Vermijd vocht.  
**(DK)** Undgå fugt.

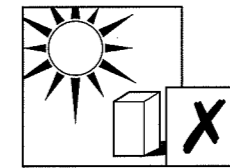

**(GB)** Avoid direct sunlight.  
**(F)** Eviter l'exposition directe aux rayons du soleil.  
**(D)** Direktes Sonnenlicht vermeiden.  
**(I)** Evitare l'esposizione diretta ai raggi del sole.  
**(ES)** Evite la luz directa del sol.  
**(P)** Evite a exposição directa à luz do sol.  
**(NL)** Vermijd rechtstreeks zonlicht.  
**(DK)** Undgå direkte sollys.

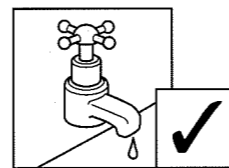

**(GB)** Clean with a damp lint free cloth.  
**(F)** Nettoyer à l'aide d'un chiffon humide, non pelucheux.  
**(D)** Mit einem angefeuchteten, nicht fuselnden Tuch abwischen.  
**(I)** Pulire con un panno umido non sfilacciato.  
**(ES)** Limpie con un paño húmedo.  
**(P)** Limpe com um pano húmido sem pêlos.  
**(NL)** Reinigen met een vochtige niet pluizende doek.  
**(DK)** Rengør med en fugtig klud, der ikke frugter.

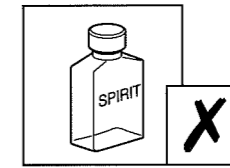

**(GB)** Do not use spirit based cleaners.  
**(F)** Ne pas utiliser d'agents nettoyeurs à base d'alcool.  
**(D)** Keine alkoholhaltigen Reinigungsmittel verwenden.  
**(I)** Non utilizzare prodotti a base di alcol.  
**(ES)** No use limpiadores con base de alcohol.  
**(P)** Não utilize produtos de limpeza à base de álcool.  
**(NL)** Gebruik geen reinigingsproducten op basis van alcohol.  
**(DK)** Brug ikke rengøringsmidler med alkohol.



**(GB)** **SAFETY NOTICE!** trailing cables are dangerous, secure all cables.  
**(F)** **SICHERHEITSHINWEIS!** Les câbles de haut-parleurs traînant sur le sol peuvent être source de danger. Fixer tous les câbles.  
**(D)** **SICHERHEITSHINWEIS!** Herumliegende Lautsprecherkabel sind eine Gefahrenquelle. Bitte alle Lautsprecherkabel sorgfältig verlegen.  
**(I)** **NOTA PER LA SICUREZZA:** i cavi di uscita dei diffusori possono essere pericolosi se non sistemati in un posto sicuro.  
**(ES)** **¡ATENCIÓN!** los cables de conexión sueltos de los altavoces son peligrosos. Fíjelos.  
**(P)** **Precauções de segurança!** Os cabos das colunas espalhados são perigosos, fixe todos os cabos.  
**(NL)** **VOOR UW VEILIGHEID!** Loshangende luidsprekerkabels zijn gevaarlijk! De kabels steeds op een veilige plaats leggen.  
**(DK)** **BEMÆRK!** skarpe knæk og slid på højttalerledningerne er farlig, de skal fastgøres.

(GB) Positioning  
 (F) Positionnement  
 (D) Aufstellung  
 (I) Posizionamento

(ES) Posicionamiento  
 (P) Posicionamento  
 (NL) Plaats en aansluiting  
 (DK) Placering

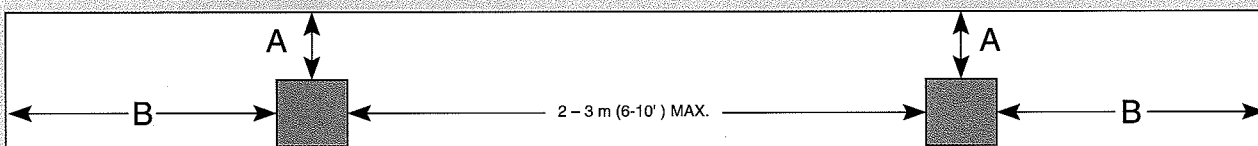

A = 225mm (9") MIN.  
 B = 1 m (36") MIN.

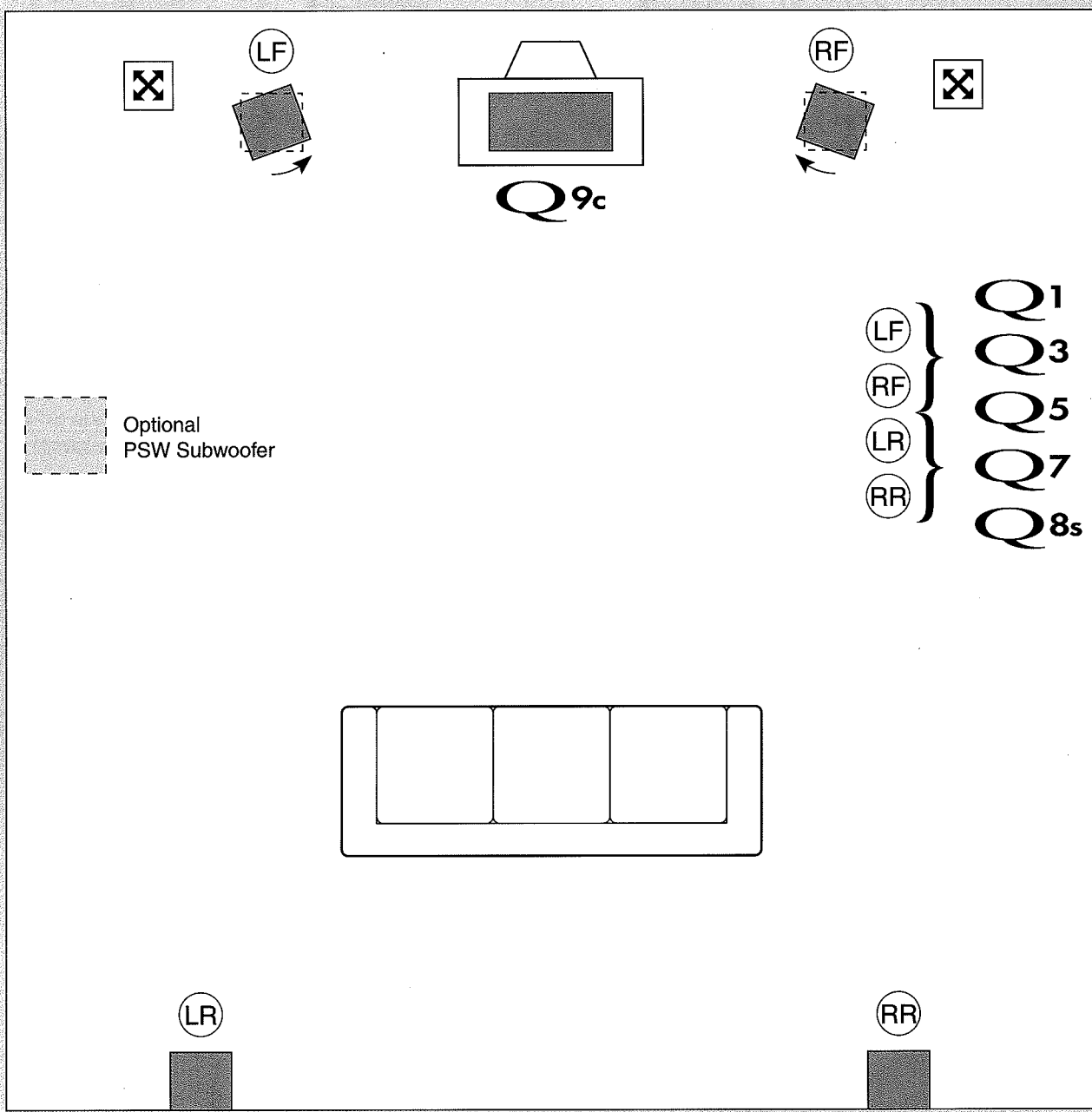

- (GB) Positioning
- (F) Positionnement
- (D) Aufstellung
- (I) Posizionamento

- (ES) Posicionamiento
- (P) Posicionamento
- (NL) Plaats en aansluiting
- (DK) Placering

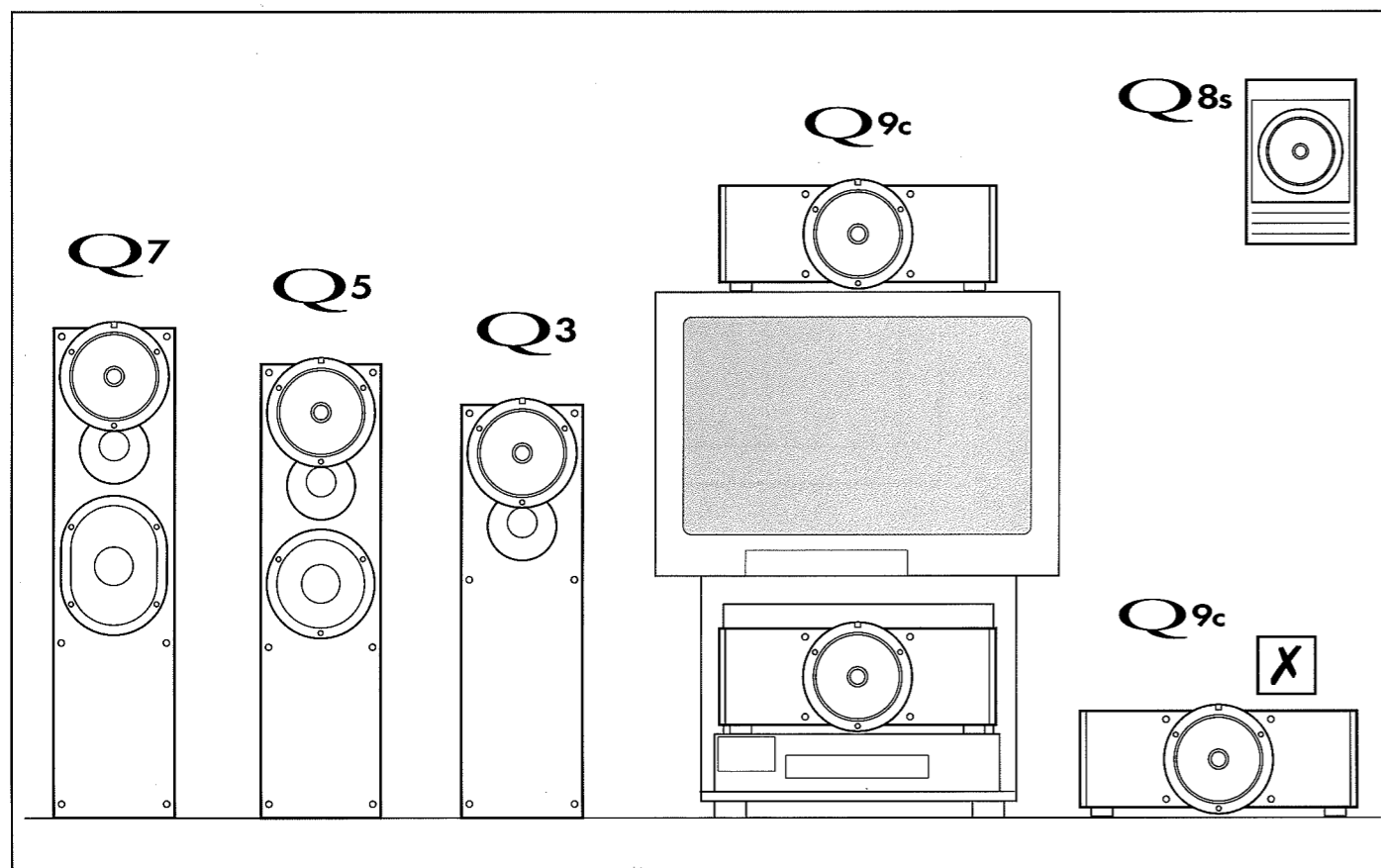
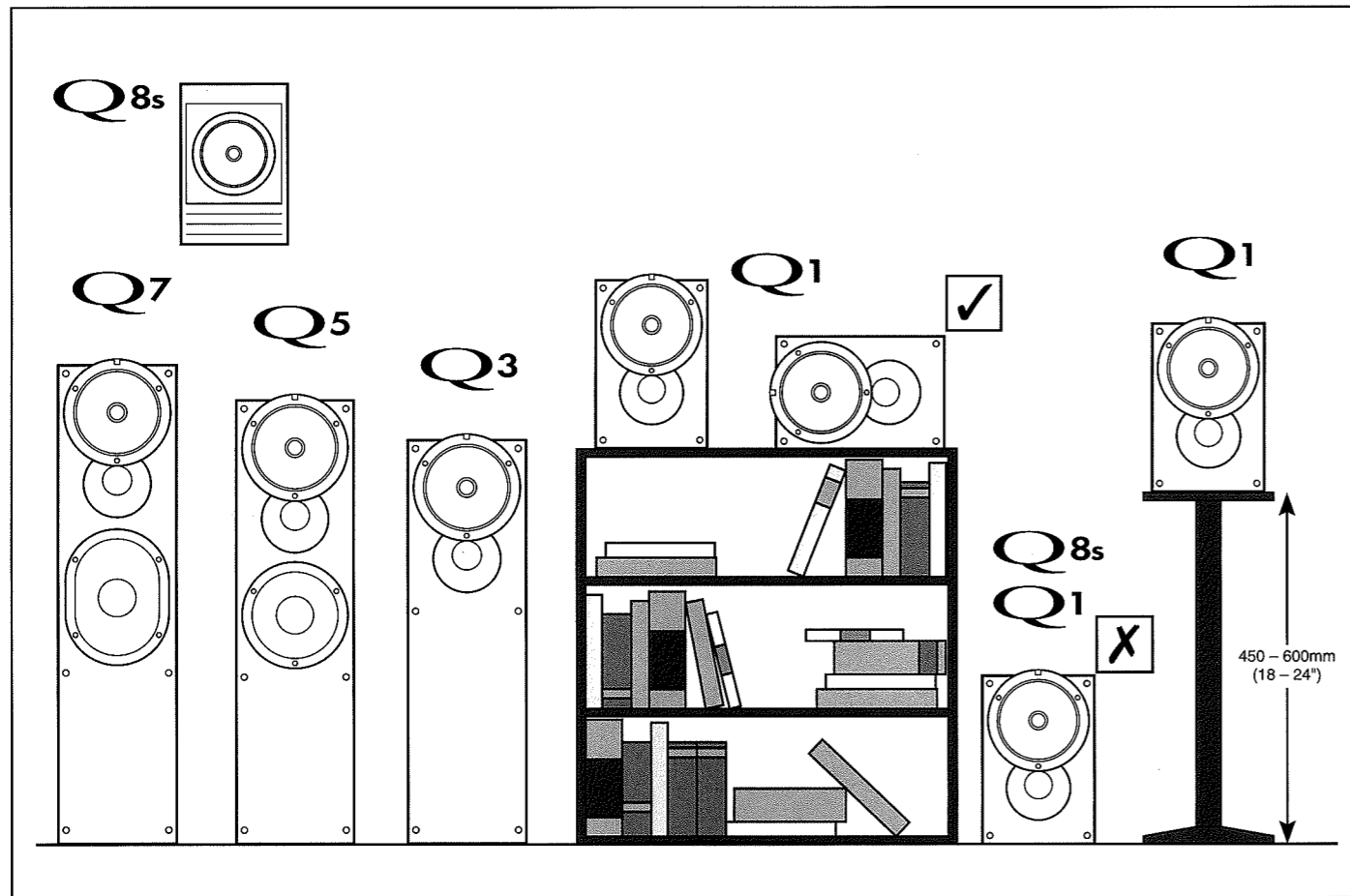

- (GB) Connections
- (F) Connexions
- (D) Anschlüsse
- (I) Collegamenti

- (ES) Conexiones
- (P) Ligações
- (NL) Aansluitingen
- (DK) Forbindelser



- (GB) Single wire connections
- (F) Connexion à un fil
- (D) Einzel-Kabelanschlüsse
- (I) Connessioni "single wire"
- (ES) Conexiones de un solo hilo
- (P) Ligações com um só cabo
- (NL) Enkelvoudige draadverbindingen
- (DK) Forbindelser til enkelt ledning

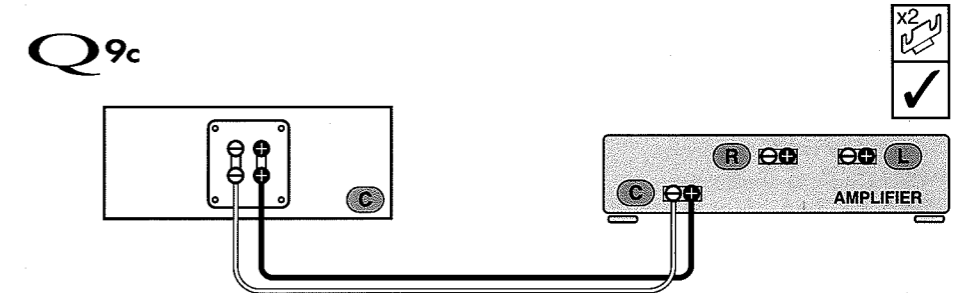

- (GB) Bi-wired connections
- (F) Connexion à bi-câblage
- (D) Doppel-Kabelanschlüsse
- (I) Connessioni "bi-wired"
- (ES) Conexiones de doble hilo
- (P) Ligações em duplo cabo
- (NL) Bi-Wire connectoren
- (DK) Bi-wired forbindelser

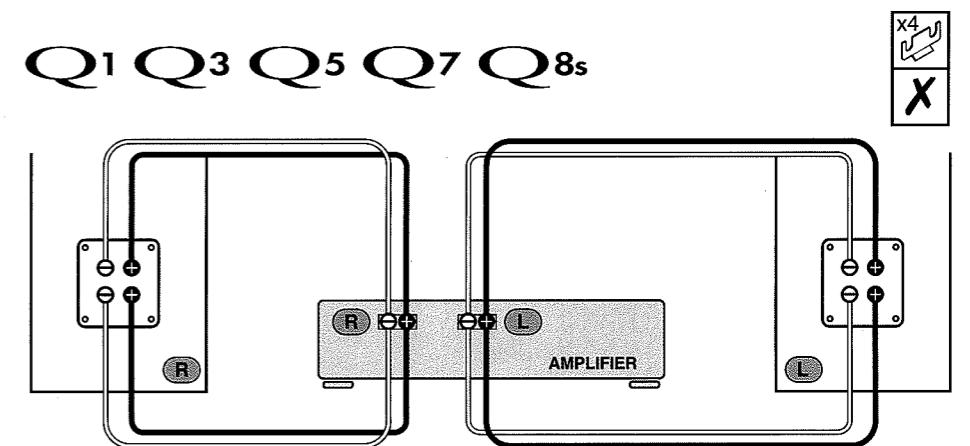
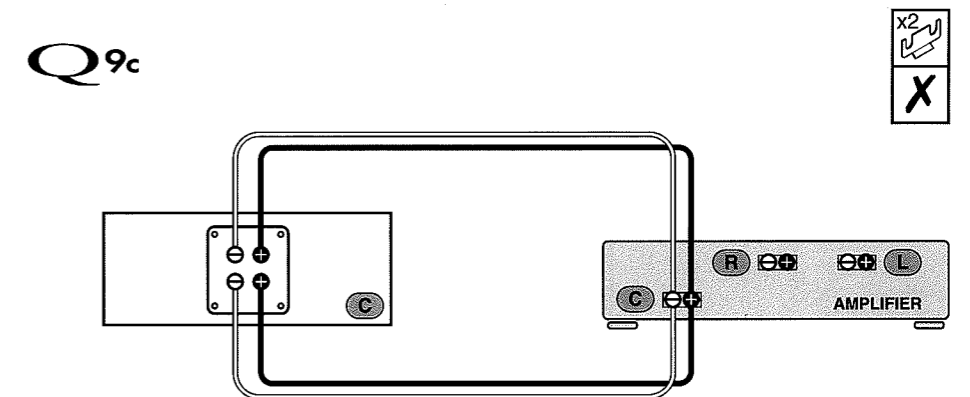
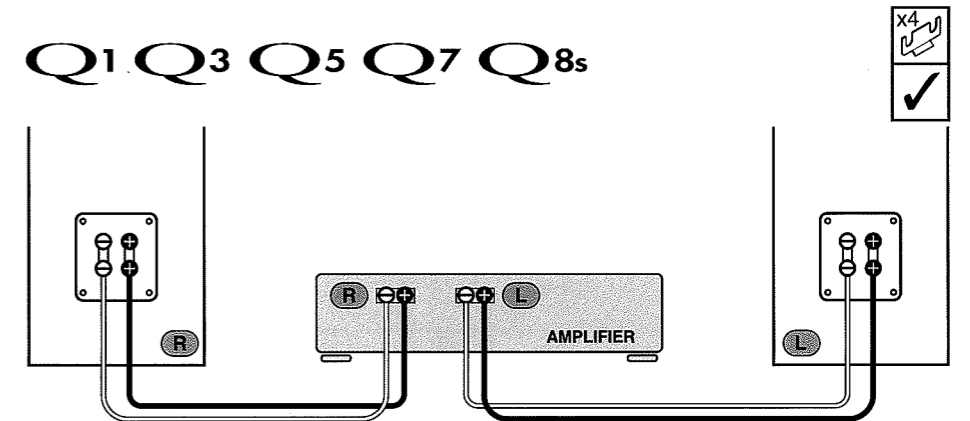

- (GB) Connections
- (F) Connexions
- (D) Anschlüsse
- (I) Collegamenti

- (ES) Conexiones
- (P) Ligações
- (NL) Aansluitingen
- (DK) Forbindelser

3



- (GB) Bi-amplified connections
- (F) Connexion à bi-amplification
- (D) Doppelte Verstärkeranschlüsse
- (I) Connessioni "bi-amplification"
- (ES) Conexiones de biamplificación
- (P) Ligações bi-amplificadas
- (NL) Bi-Amp aansluitingen
- (DK) Forbindelser til bi-amping

Q9c

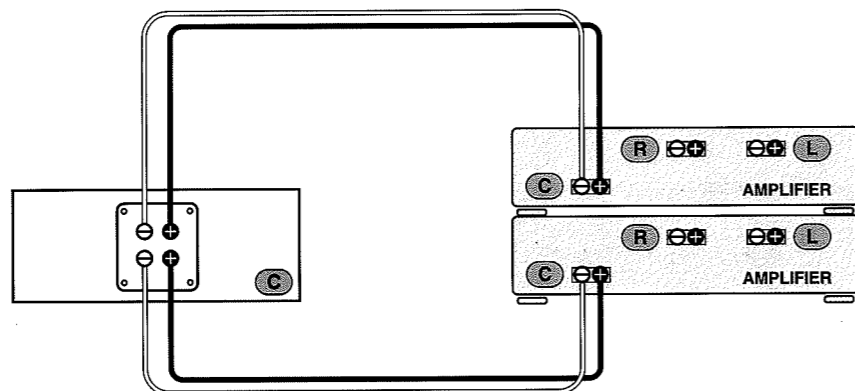

Q1 Q3 Q5 Q7 Q8s

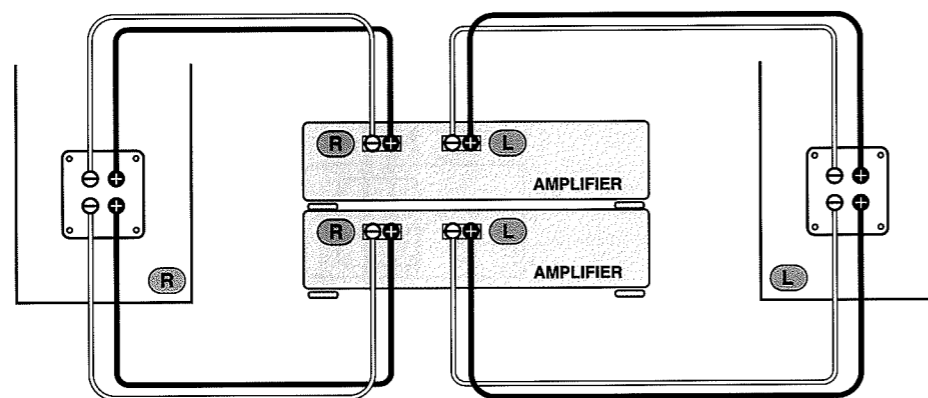

- (GB) Fault Finding - (1) Problem / (2) Action / (3) Cause
- (F) Dépannage - (1) Problème / (2) Action / (3) Cause
- (D) Fehlersuche - (1) Problem / (2) Maßnahme / (3) Ursache
- (I) Individuazione delle anomalie - (1) Problema / (2) Rimedio / (3) Causa

- (ES) Localización de averías - (1) Problema / (2) Acción / (3) Causa
- (P) Localização de avarias - (1) Problema / (2) Solução / (3) Causa
- (NL) Opsporen van storingen - (1) Probleem / (2) Handeling / (3) Oorzaak
- (DK) Fejlfinding - (1) Problem / (2) Handling / (3) Årsag

4

(1) PROBLEM	(2) ACTION	(3) CAUSE

(GB) Specifications  
 (F) Spécifications  
 (D) Technische Merkmale  
 (I) Specifiche

(ES) Especificaciones  
 (P) Especificações  
 (NL) Technische gegevens  
 (DK) Specifikationer

5

Model	Q1	Q3	Q5
Design	Two way bass reflex	Two way bass reflex	Two and a half way bass reflex
Drive Units	165 mm (6 1/2") Uni-Q® with 19 mm (3/4") aluminium dome HF	165 mm (6 1/2") Uni-Q® with 19 mm (3/4") aluminium dome HF	165 mm (6 1/2") woofer 165 mm (6 1/2") Uni-Q® with 19 mm (3/4") aluminium dome HF
Frequency response at ± 3 dB	45 - 27 kHz	42 - 27 kHz	39 - 27 kHz
Crossover frequency	2.8 kHz	2.8 kHz	2.8 kHz
Amplifier requirements	15 - 120W	15 - 120W	15 - 150W
Sensitivity (2.83V/1m)	91 dB	91 dB	91 dB
Maximum output	111 dB	111 dB	112 dB
Impedance	8 Ω	8 Ω	8 Ω
Magnetic shielding	Yes	Yes	Yes
Weight	6.41 kg (14.1 lbs)	11.5 kg (25.3 lbs)	14.5 kg (32 lbs)
Dimensions (H x W x D)	355 x 222 x 326 mm 14 x 8.7 x 12.8 inches	812 x 232 x 337 mm 31.9 x 9.1 x 13.2 inches	912 x 232 x 337 mm 35.9 x 9.1 x 13.2 inches
Finishes	Black Ash, Maple or Dark Apple	Black Ash, Maple or Dark Apple	Black Ash, Maple or Dark Apple

Model	Q7	Q8s	Q9c
Design	Three way bass reflex	Two way closed box	Two way bass reflex
Drive Units	228 x 152 mm (9" x 6") Racetrack woofer 165 mm (6 1/2") Uni-Q® with 19 mm (3/4") aluminium dome HF	165 mm (6 1/2") Uni-Q® with 19 mm (3/4") aluminium dome HF	165 mm (6 1/2") Uni-Q® with 19 mm (3/4") aluminium dome HF
Frequency response at ± 3 dB	35 Hz - 27 kHz	120 Hz - 27 kHz	50 Hz - 27 kHz
Crossover frequency	120 Hz - 2.8 kHz	2.8 kHz	2.8 kHz
Amplifier requirements	15 - 175W	15 - 120W	15 - 120W
Sensitivity (2.83V/1m)	91 dB	90 dB	91 dB
Maximum output	113 dB	108 dB	111 dB
Impedance	8 Ω	8 Ω	8 Ω
Magnetic shielding	Yes	Yes	Yes
Weight	17.58 kg (38.8 lbs)	3.1 kg (6.82 lbs)	6.2 kg (13.6 lbs)
Dimensions (H x W x D)	987 x 258 x 366 mm 38.8 x 10.1 x 14.4 inches	253 x 170 x 119 mm 10 x 6.7 x 4.7 inches	209 x 480 x 296 mm 8.2 x 18.9 x 11.7 inches
Finishes	Black Ash, Maple or Dark Apple	Video Grey	Black Ash, Maple or Dark Apple

KEF AUDIO reserve the right, in line with continuous research and development, to amend or change specifications without prior notice. E. & O.E

KEF AUDIO (UK) Limited, Eccleston Road, Tovil,  
 Maidstone, Kent ME15 6QP U.K.  
 Telephone: +44 (0) 1622 672261 Fax: +44 (0) 1622 750653

ADCOM, 10 Timber Lane, Marlboro,  
 New Jersey 07746 U.S.A.  
 Telephone: (1) 732 683 2356 Fax: (1) 732 683 2358

[www.kef.com](http://www.kef.com)

[www.adcom.com](http://www.adcom.com)

